

## FEATURES

- **Gain-Bandwidth: 150MHz**
- **Gain of 4 Stable**
- **Slew Rate: 250V/ $\mu$ s**
- Input Noise Voltage:  $6nV/\sqrt{Hz}$
- C-Load™ Op Amp Drives Capacitive Loads
- Maximum Input Offset Voltage: 600 $\mu$ V
- Maximum Input Bias Current: 300nA
- Maximum Input Offset Current: 300nA
- Minimum Output Swing Into 500 $\Omega$ :  $\pm 12V$
- Minimum DC Gain: 50V/mV,  $R_L = 500\Omega$
- Settling Time to 0.1%: 65ns, 10V Step
- Settling Time to 0.01%: 85ns, 10V Step
- Differential Gain: 0.08%,  $A_V = 4$ ,  $R_L = 150\Omega$
- Differential Phase: 0.2°,  $A_V = 4$ ,  $R_L = 150\Omega$

## APPLICATIONS

- Wideband Amplifiers
- Buffers
- Active Filters
- Video and RF Amplification
- Cable Drivers
- 8-, 10-, 12-Bit Data Acquisition Systems

## DESCRIPTION

The LT<sup>®</sup>1221 is a very high speed operational amplifier with superior DC performance. The LT1221 is stable in a noise gain of 4 or greater. It features reduced input offset voltage, lower input bias currents and higher DC gain than devices with comparable bandwidth and slew rate. The circuit is a single gain stage that includes proprietary DC gain enhancement circuitry to obtain precision with high speed. The high gain and fast settling time make the circuit an ideal choice for data acquisition systems. The circuit is also capable of driving capacitive loads which makes it useful in buffer or cable driver applications.

The LT1221 is a member of a family of fast, high performance amplifiers that employ Linear Technology Corporation's advanced complementary bipolar processing. For unity-gain stable applications the LT1220 can be used, and for gains of 10 or greater the LT1222 can be used.

 LTC and LT are registered trademarks of Linear Technology Corporation  
 C-Load is a trademark of Linear Technology Corporation

## TYPICAL APPLICATION

Summing Amplifier

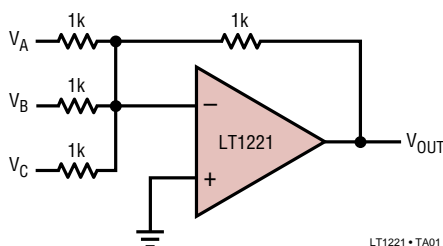

Summing Amplifier Large-Signal Response

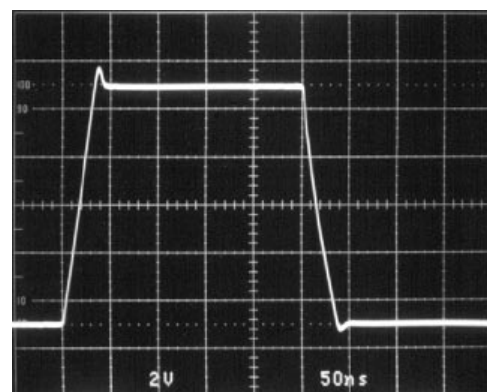

$V_S = \pm 15V$      $f = 2MHz$   
 $V_{IN} = 10V_{P-P}$

LT1221 • TA02

# LT1221

## ABSOLUTE MAXIMUM RATINGS (Note 1)

Total Supply Voltage ( $V^+$ to $V^-$ ) .....	36V	Operating Temperature Range	
Differential Input Voltage .....	$\pm 6V$	LT1221C .....	-40°C TO 85°C
Input Voltage .....	$\pm V_S$	LT1221M (OBSOLETE) .....	-55°C to 125°C
Output Short-Circuit Duration (Note 2) .....	Indefinite	Maximum Junction Temperature (See Below)	
Specified Temperature Range		Plastic Package .....	150°C
LT1221C (Note 3) .....	0°C to 70°C	Ceramic Package (OBSOLETE) .....	175°C
LT1221M (OBSOLETE) .....	-55°C to 125°C	Storage Temperature Range .....	-65°C to 150°C
		Lead Temperature (Soldering, 10 sec) .....	300°C

## PACKAGE/ORDER INFORMATION

<p>TOP VIEW NULL 1 8 2 7 V+ -IN 3 6 VOUT +IN 4 5 NC V- H PACKAGE 8-LEAD TO-5 METAL CAN <math>T_{JMAX} = 175^\circ\text{C}</math>, <math>\theta_{JA} = 150^\circ\text{C/W}</math></p>	ORDER PART NUMBER	<p>TOP VIEW NULL 1 8 NULL -IN 2 7 V+ +IN 3 6 VOUT V- 4 5 NC</p> <p>N8 PACKAGE 8-LEAD PLASTIC DIP <math>T_{JMAX} = 150^\circ\text{C}</math>, <math>\theta_{JA} = 130^\circ\text{C/W}</math> (N) <math>T_{JMAX} = 150^\circ\text{C}</math>, <math>\theta_{JA} = 190^\circ\text{C/W}</math> (S)</p> <p>S8 PACKAGE 8-LEAD PLASTIC SOIC <math>T_{JMAX} = 175^\circ\text{C}</math>, <math>\theta_{JA} = 100^\circ\text{C/W}</math> (J)</p>	ORDER PART NUMBER
	SPECIAL ORDER CONSULT FACTORY		ORDER PART NUMBER
<p><b>OBSOLETE PACKAGE</b> Consider the N8 or S8 Package for Alternate Source</p>			S8 PART MARKING
			1221
			ORDER PART NUMBER
			LT1221MJ8
			<b>OBSOLETE PACKAGE</b> Consider the N8 Package for Alternate Source

Consult LTC Marketing for parts specified with wider operating temperature ranges.

## ELECTRICAL CHARACTERISTICS $T_A = 25^\circ\text{C}$ , $V_S = \pm 15V$ , $T_A = 25^\circ\text{C}$ , $V_{CM} = 0V$ , unless otherwise specified.

SYMBOL	PARAMETER	CONDITIONS	MIN	TYP	MAX	UNITS
$V_{OS}$	Input Offset Voltage	(Note 4)		200	600	$\mu\text{V}$
$I_{OS}$	Input Offset Current			100	300	nA
$I_B$	Input Bias Current			100	300	nA
$e_n$	Input Noise Voltage	$f = 10\text{kHz}$		6		$\text{nV}/\sqrt{\text{Hz}}$
$i_n$	Input Noise Current	$f = 10\text{kHz}$		2		$\text{pA}/\sqrt{\text{Hz}}$
$R_{IN}$	Input Resistance	$V_{CM} = \pm 12V$ Differential	20	45 80		$\text{M}\Omega$ $\text{k}\Omega$
$C_{IN}$	Input Capacitance			2		pF
	Input Voltage Range (Positive)		12	14		V
	Input Voltage Range (Negative)			-13	-12	V
CMRR	Common Mode Rejection Ratio	$V_{CM} = \pm 12V$	92	114		dB
PSRR	Power Supply Rejection Ratio	$V_S = \pm 5V$ to $\pm 15V$	90	110		dB
$A_{VOL}$	Large-Signal Voltage Gain	$V_{OUT} = \pm 10V$ , $R_L = 500\Omega$	50	100		V/mV
$V_{OUT}$	Output Swing	$R_L = 500\Omega$	12	13		$\pm V$
$I_{OUT}$	Output Current	$V_{OUT} = \pm 12V$	24	26		mA
SR	Slew Rate	(Note 5)	200	250		V/ $\mu\text{s}$
	Full Power Bandwidth	10V Peak (Note 6)		4		MHz
GBW	Gain-Bandwidth	$f = 1\text{MHz}$		150		MHz

**ELECTRICAL CHARACTERISTICS**  $V_S = \pm 15V$ ,  $T_A = 25^\circ C$ ,  $V_{CM} = 0V$ , unless otherwise specified.

SYMBOL	PARAMETER	CONDITIONS	MIN	TYP	MAX	UNITS
$t_r, t_f$	Rise Time, Fall Time	$A_V = 4$ , 10% to 90%, 0.1V		3.2		ns
	Overshoot	$A_V = 4$ , 0.1V		10		%
	Propagation Delay	$A_V = 4$ , 50% $V_{IN}$ to 50% $V_{OUT}$ , 0.1V		5.4		ns
$t_s$	Settling Time	10V Step, 0.1%		65		ns
		10V Step, 0.01%		85		ns
	Differential Gain	$f = 3.58MHz$ , $R_L = 150\Omega$ (Note 7)		0.08		%
		$f = 3.58MHz$ , $R_L = 1k$ (Note 7)		0.02		%
	Differential Phase	$f = 3.58MHz$ , $R_L = 150\Omega$ (Note 7)		0.20		DEG
		$f = 3.58MHz$ , $R_L = 1k$ (Note 7)		0.05		DEG
$R_O$	Output Resistance	$A_V = 4$ , $f = 1MHz$		0.3		$\Omega$
$I_S$	Supply Current			8	10.5	mA

The ● denotes the specifications which apply over the temperature range  $0^\circ C \leq T_A \leq 70^\circ C$ , otherwise specifications are at  $T_A = 25^\circ C$ .  $V_S = \pm 15V$ ,  $V_{CM} = 0V$ , unless otherwise specified.

SYMBOL	PARAMETER	CONDITIONS	MIN	TYP	MAX	UNITS
$V_{OS}$	Input Offset Voltage	(Note 4)	●	0.2	1.5	mV
	Input $V_{OS}$ Drift		●	15		$\mu V/^\circ C$
$I_{OS}$	Input Offset Current		●	100	400	nA
$I_B$	Input Bias Current		●	100	400	nA
CMRR	Common Mode Rejection Ratio	$V_{CM} = \pm 12V$	●	92	114	dB
PSRR	Power Supply Rejection Ratio	$V_S = \pm 5V$ to $\pm 15V$	●	90	110	dB
$A_{VOL}$	Large-Signal Voltage Gain	$V_{OUT} = \pm 10V$ , $R_L = 500\Omega$	●	40	100	V/mV
$V_{OUT}$	Output Swing	$R_L = 500\Omega$	●	12	13	$\pm V$
$I_{OUT}$	Output Current	$V_{OUT} = \pm 12V$	●	24	26	mA
SR	Slew Rate	(Note 5)	●	180	250	V/ $\mu s$
$I_S$	Supply Current		●	8	11	mA

The ● denotes the specifications which apply over the temperature range  $-55^\circ C \leq T_A \leq 125^\circ C$ , otherwise specifications are at  $T_A = 25^\circ C$ .  $V_S = \pm 15V$ ,  $V_{CM} = 0V$ , unless otherwise specified.

SYMBOL	PARAMETER	CONDITIONS	MIN	TYP	MAX	UNITS
$V_{OS}$	Input Offset Voltage	(Note 4)	●	0.2	2	mV
	Input $V_{OS}$ Drift		●	15		$\mu V/^\circ C$
$I_{OS}$	Input Offset Current		●	100	800	nA
$I_B$	Input Bias Current		●	100	1000	nA
CMRR	Common Mode Rejection Ratio	$V_{CM} = \pm 12V$	●	92	114	dB
PSRR	Power Supply Rejection Ratio	$V_S = \pm 5V$ to $\pm 15V$	●	90	110	dB
$A_{VOL}$	Large-Signal Voltage Gain	$V_{OUT} = \pm 10V$ , $R_L = 500\Omega$	●	12.5	100	V/mV
$V_{OUT}$	Output Swing	$R_L = 500\Omega$	●	10	13	$\pm V$
		$R_L = 1k$	●	12	13	$\pm V$
$I_{OUT}$	Output Current	$V_{OUT} = \pm 10V$	●	20	26	mA
		$V_{OUT} = \pm 12V$	●	12	13	mA
SR	Slew Rate	(Note 5)	●	130	250	V/ $\mu s$
$I_S$	Supply Current		●	8	11	mA

**Note 1:** Absolute Maximum Ratings are those values beyond which the life of a device may be impaired.

**Note 2:** A heat sink may be required when the output is shorted indefinitely.

**Note 3:** Commercial parts are designed to operate over  $-40^\circ C$  to  $85^\circ C$ , but are not tested nor guaranteed beyond  $0^\circ C$  to  $70^\circ C$ . Industrial grade parts specified and tested over  $-40^\circ C$  to  $85^\circ C$  are available on special request. Consult factory.

**Note 4:** Input offset voltage is pulse tested and is exclusive of warm-up drift.

**Note 5:** Slew rate is measured between  $\pm 10V$  on an output swing of  $\pm 12V$ .

**Note 6:**  $FPBW = SR/2\pi V_p$ .

**Note 7:** Differential Gain and Phase are tested in  $A_V = 4$  with five amps in series. Attenuators of 1/4 are used as loads ( $36.5\Omega$ ,  $110\Omega$  and  $249\Omega$ ,  $750\Omega$ ).

# TYPICAL PERFORMANCE CHARACTERISTICS

**Input Common Mode Range vs Supply Voltage**

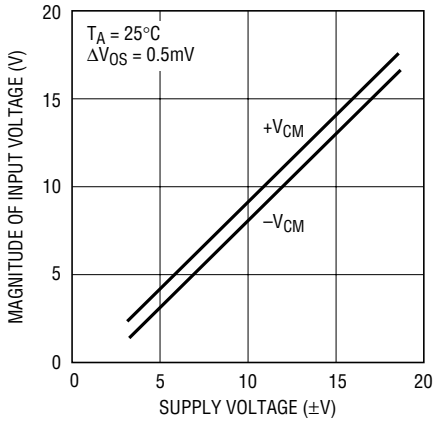

LT1221 • TPC01

**Supply Current vs Supply Voltage and Temperature**

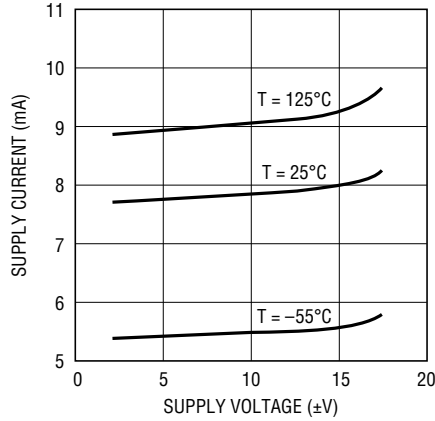

LT1221 • TPC02

**Output Voltage Swing vs Supply Voltage**

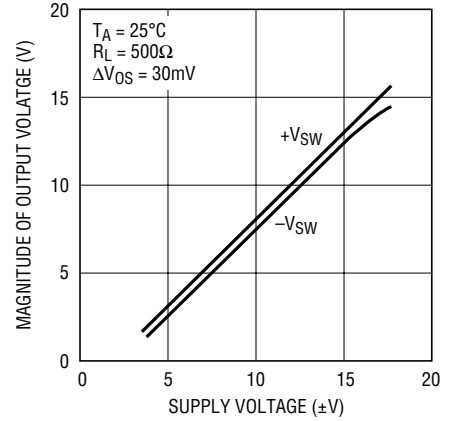

LT1221 • TPC03

**Output Voltage Swing vs Resistive Load**

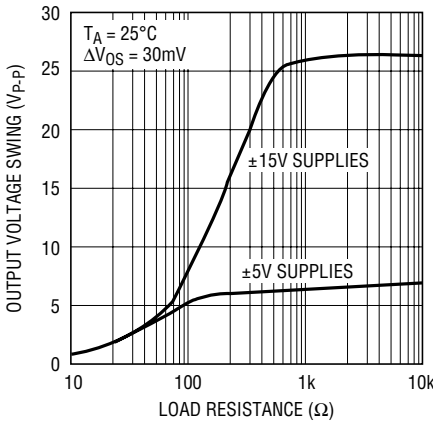

LT1221 • TPC04

**Input Bias Current vs Input Common Mode Voltage**

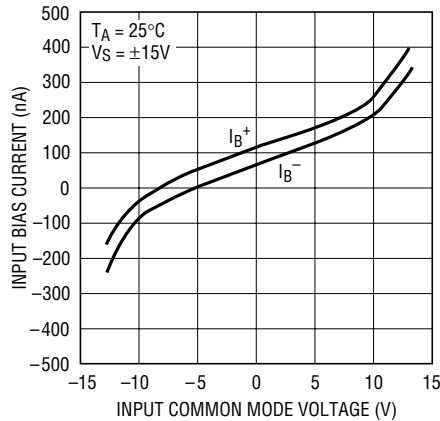

LT1221 • TPC05

**Open-Loop Gain vs Resistive Load**

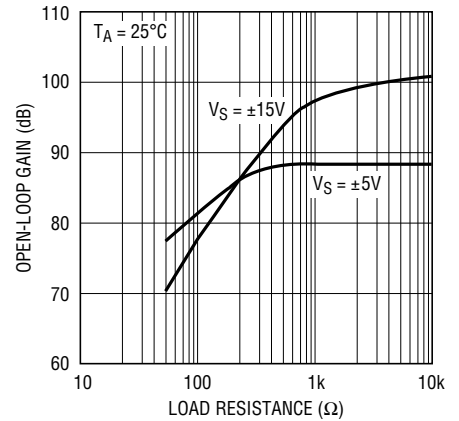

LT1221 • TPC06

**Output Short-Circuit Current vs Temperature**

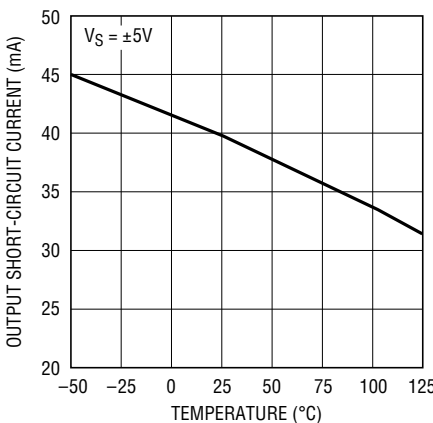

LT1221 • TPC07

**Input Noise Spectral Density**

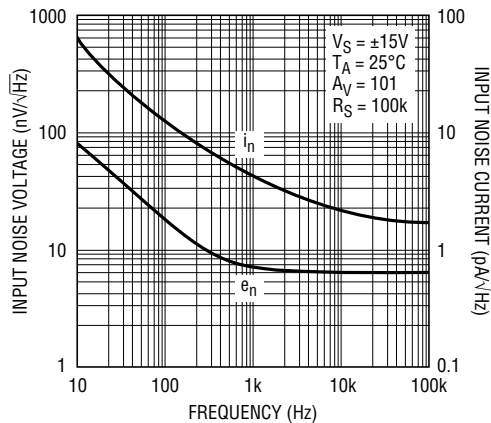

LT1221 • TPC08

**Power Supply Rejection Ratio vs Frequency**

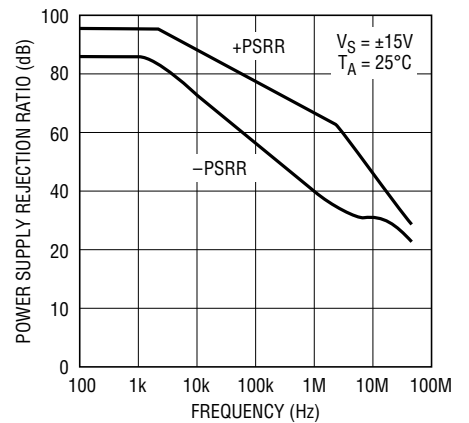

LT1221 • TPC09

# TYPICAL PERFORMANCE CHARACTERISTICS

**Common Mode Rejection Ratio vs Frequency**

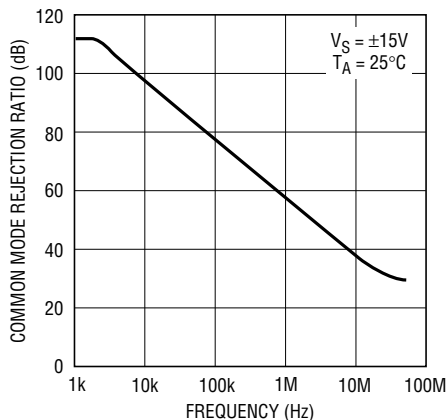

LT1221 • TPC10

**Output Swing and Error vs Settling Time (Noninverting)**

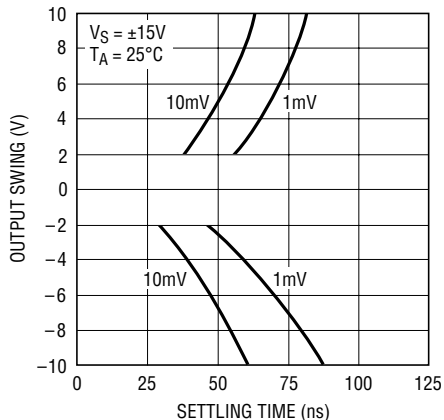

LT1220 • TPC11

**Output Swing and Error vs Settling Time (Inverting)**

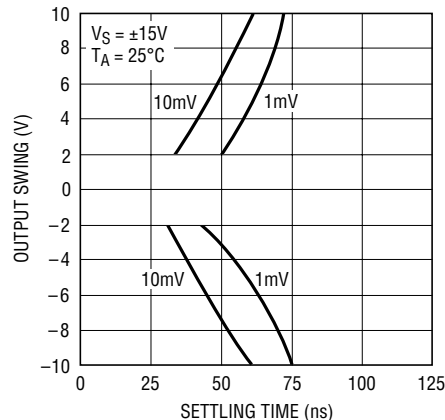

LT1221 • TPC12

**Voltage Gain and Phase vs Frequency**

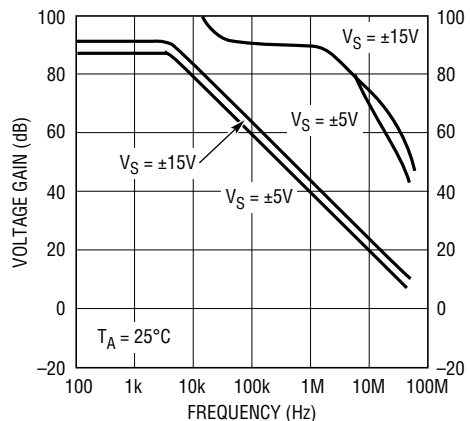

LT1221 • TPC13

**Frequency Response vs Capacitive Load**

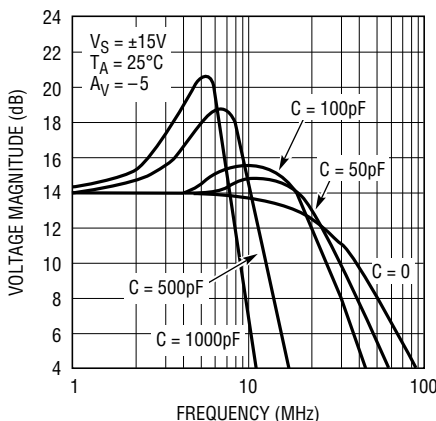

LT1221 • TPC14

**Closed-Loop Output Impedance vs Frequency**

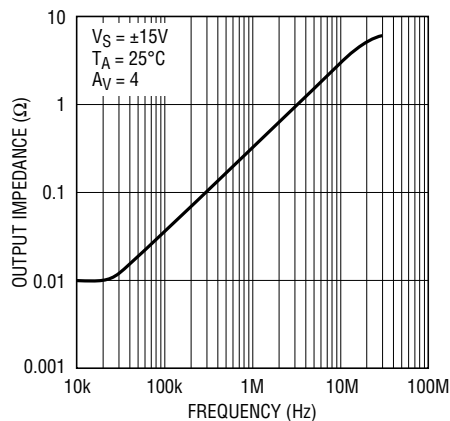

LT1221 • TPC15

**Gain-Bandwidth vs Temperature**

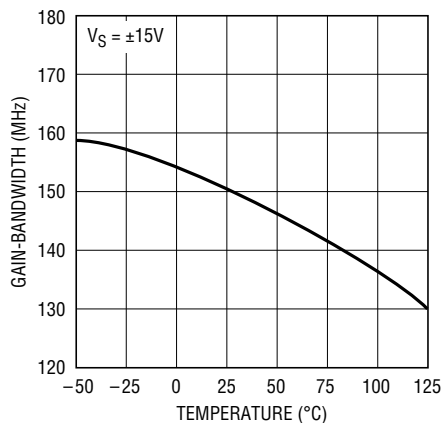

LT1221 • TPC16

**Slew Rate vs Temperature**

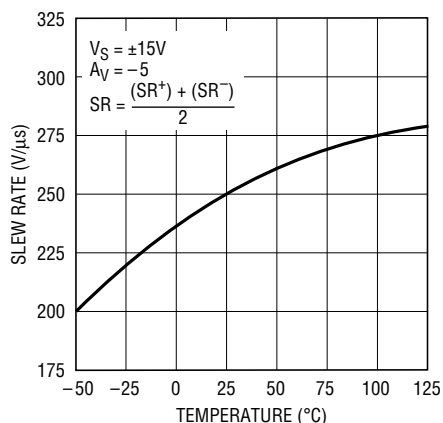

LT1221 • TPC19

**Total Harmonic Distortion vs Frequency**

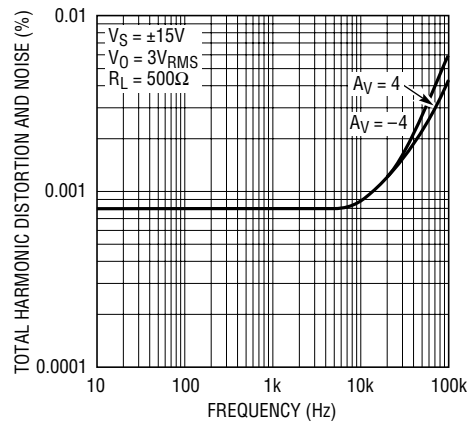

LT1220 • TPC18

## TYPICAL PERFORMANCE CHARACTERISTICS

Small Signal,  $A_V = 4$

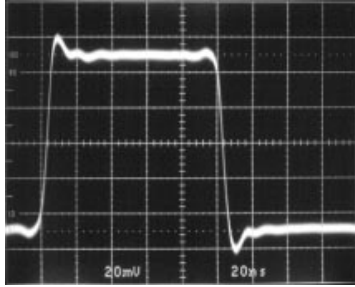

$V_S = \pm 15V$   $f = 5MHz$   $V_{IN} = 25mV$  LT1221 • TPC19

Large Signal,  $A_V = 4$

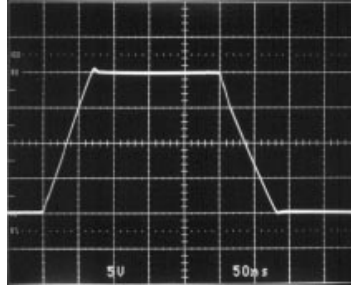

$V_S = \pm 15V$   $f = 2MHz$   $V_{IN} = 5V_{p-p}$  LT1221 • TPC20

Large Signal,  $A_V = 4$ ,  
 $C_L = 10,000pF$

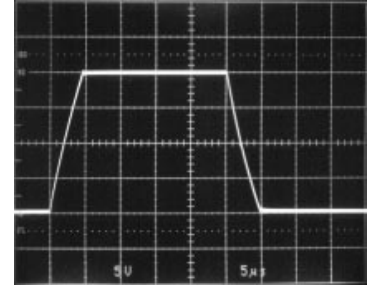

$V_S = \pm 15V$   $f = 20kHz$   $V_{IN} = 5V_{p-p}$  LT1221 • TPC21

Small Signal,  $A_V = -4$

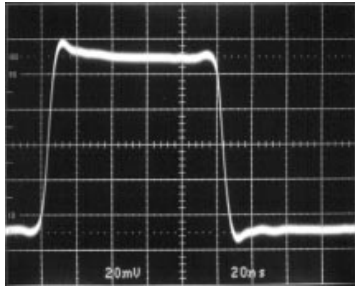

$V_S = \pm 15V$   $f = 5MHz$   $V_{IN} = 25mV$  LT1221 • TPC22

Large Signal,  $A_V = -4$

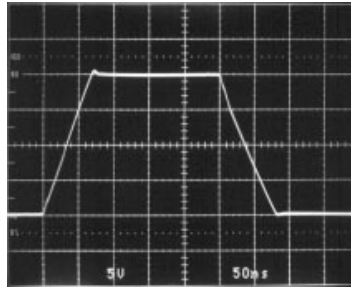

$V_S = \pm 15V$   $f = 2MHz$   $V_{IN} = 5V_{p-p}$  LT1221 • TPC23

Small Signal,  $A_V = -4$ ,  
 $C_L = 1,000pF$

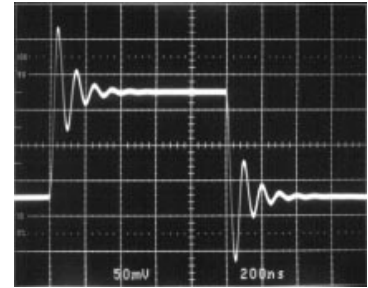

$V_S = \pm 15V$   $f = 500kHz$   $V_{IN} = 42mV$  LT1221 • TPC24

## APPLICATIONS INFORMATION

The LT1221 is stable in noise gains of 4 or greater and may be inserted directly into HA2520/2/5, HA2541/2/4, AD817, AD847, EL2020, EL2044 and LM6361 applications, provided that the nulling circuitry is removed and the amplifier configuration has a high enough noise gain. The suggested nulling circuit for the LT1221 is shown in the following figure.

Offset Nulling

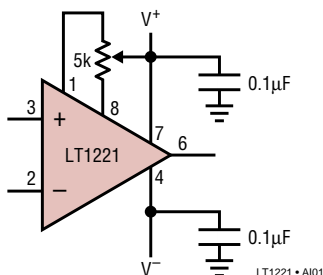

LT1221 • AI01

### Layout and Passive Components

The LT1221 amplifier is easy to apply and tolerant of less than ideal layouts. For maximum performance (for example, fast settling time) use a ground plane, short lead lengths and RF-quality bypass capacitors (0.01µF to 0.1µF). For high drive current applications use low ESR bypass capacitors (1µF to 10µF tantalum). Sockets should be avoided when maximum frequency performance is required, although low profile sockets can provide reasonable performance up to 50MHz. For more details see Design Note 50. Feedback resistors greater than 5k are not recommended because a pole is formed with the input capacitance which can cause peaking or oscillations.

### Input Considerations

Bias current cancellation circuitry is employed on the inputs of the LT1221 so the input bias current and input

## APPLICATIONS INFORMATION

offset current have identical specifications. For this reason, matching the impedance on the inputs to reduce bias current errors is not necessary.

### Capacitive Loading

The LT1221 is stable with capacitive loads. This is accomplished by sensing the load induced output pole and adding compensation at the amplifier gain node. As the capacitive load increases, both the bandwidth and phase margin decrease. There will be peaking in the frequency domain as shown in the curve of Frequency Response vs Capacitive Load. The small-signal transient response will have more overshoot as shown in the photo of the small-signal response with 1000pF load. The large-signal response with a 10,000pF load shows the output slew rate being limited to  $4V/\mu s$  by the short-circuit current. The LT1221 can drive coaxial cable directly, but for best pulse fidelity a resistor of value equal to the characteristic impedance of the cable (i.e.,  $75\Omega$ ) should be placed in series with the output. The other end of the cable should be terminated with the same value resistor to ground.

### Compensation

The LT1221 has a typical gain-bandwidth product of 150MHz which allows it to have wide bandwidth in high gain configurations (i.e., in a gain of 10, it will have a bandwidth of about 15MHz). The amplifier is stable in a noise gain of 4 so the ratio of the signal at the inverting input to the output must be  $1/4$  or less. Straightforward gain configurations of 4 or  $-3$  are stable, but there are several others that allow the amplifier to be stable for lower signal gains (the noise gain, however, remains 4 or more). One example is the summing amplifier on the first page of this data sheet. Each input signal has a gain of  $-1$  to the output, but it is easily seen that this configuration is equivalent to a gain of  $-3$  as far as the amplifier is concerned. Another circuit is shown below with a DC gain of 1, but an AC gain of 5. The break frequency of the R-C combination across the amplifier inputs should be approximately a factor of 10 less than the gain-bandwidth of the amplifier divided by the high frequency gain (in this case  $1/10$  of  $150MHz/5$  or 3MHz).

## SIMPLIFIED SCHEMATIC

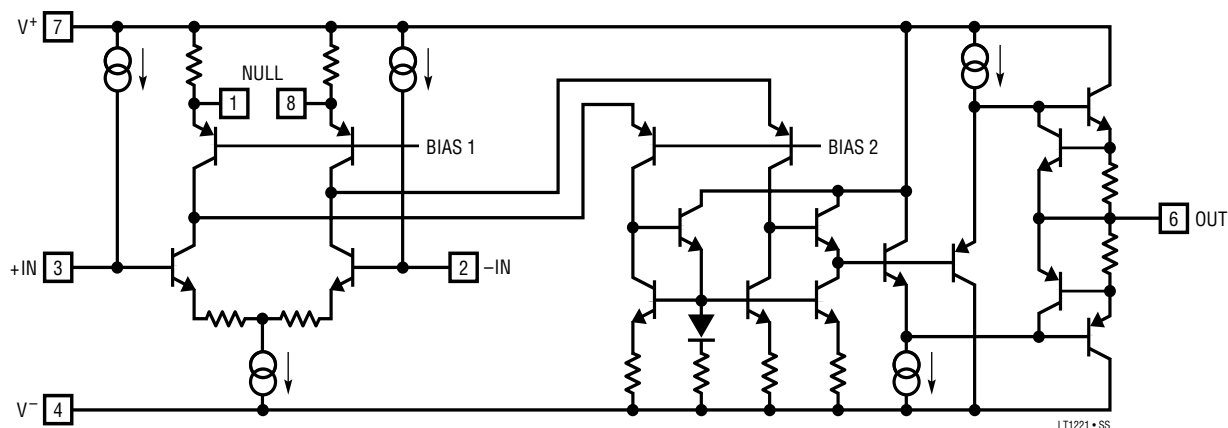

**PACKAGE DESCRIPTION**

**H Package**  
**8-Lead TO-5 Metal Can (.200 Inch PCD)**  
 (Reference LTC DWG # 05-08-1320)

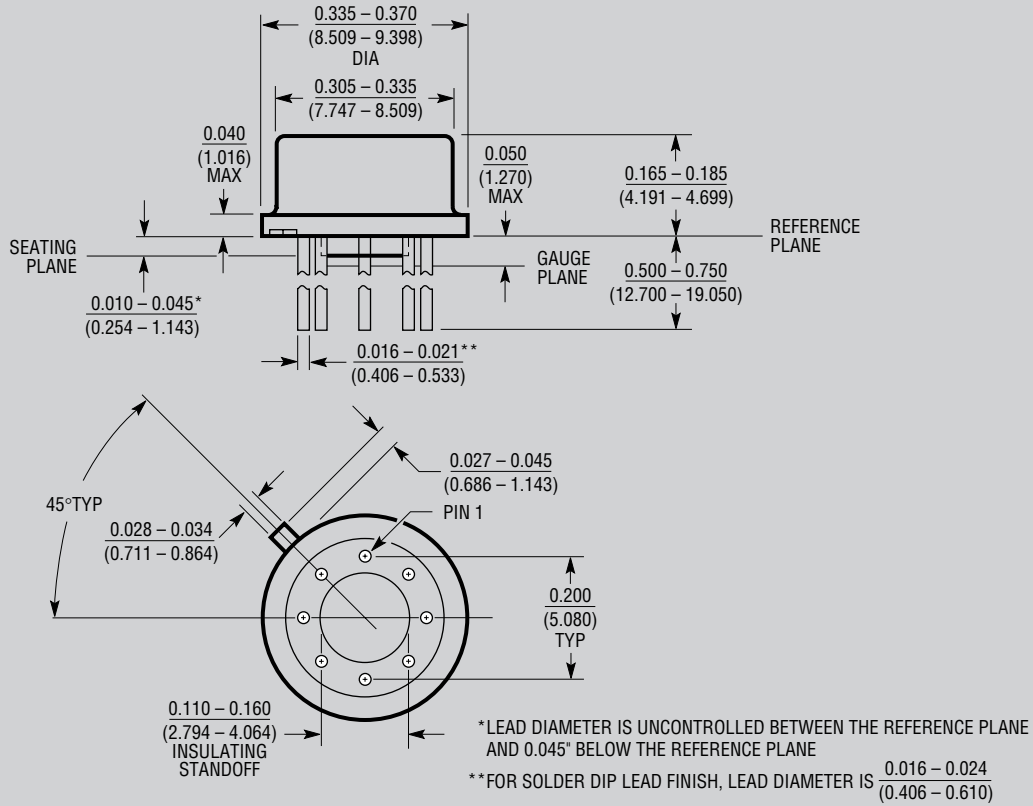

H8(TO-5) 0.200 PCD 1197

**OBsolete PACKAGE**



# PACKAGE DESCRIPTION

**J8 Package**  
**8-Lead CERDIP (Narrow .300 Inch, Hermetic)**  
 (Reference LTC DWG # 05-08-1110)

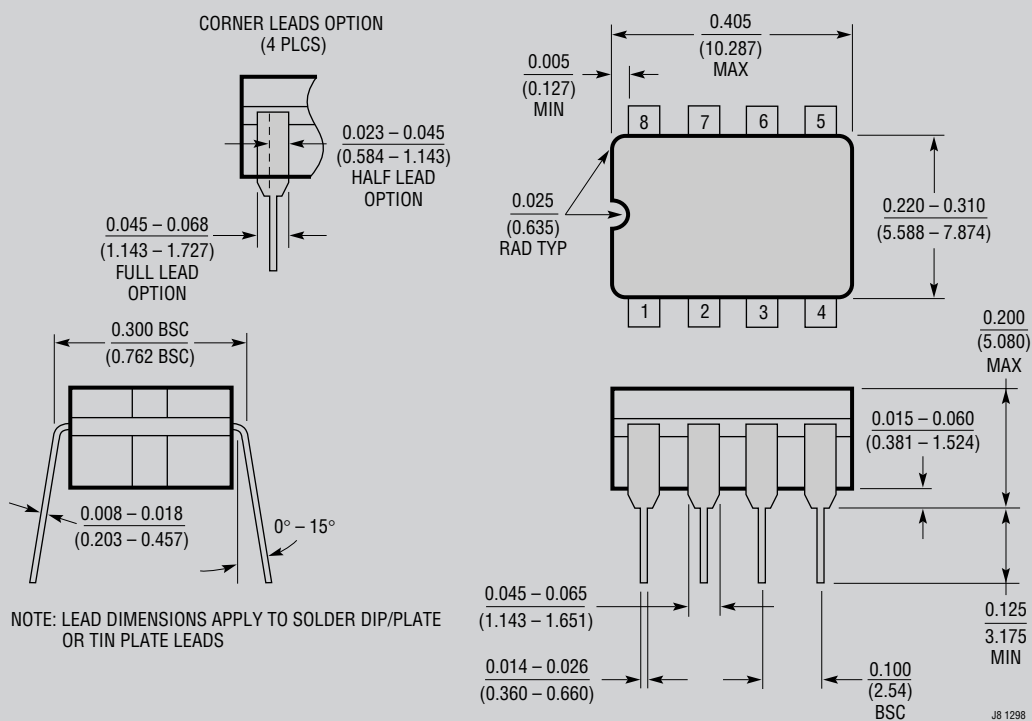

**OBsolete PACKAGE**

**PACKAGE DESCRIPTION**

**N8 Package**  
**8-Lead PDIP (Narrow .300 Inch)**  
 (Reference LTC DWG # 05-08-1510)

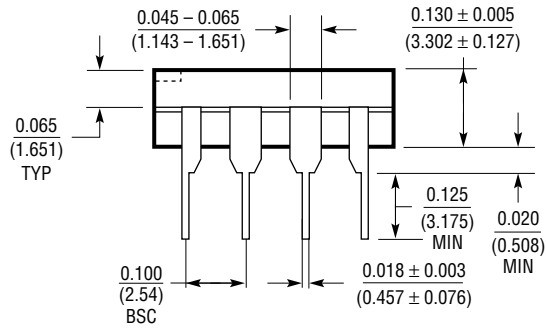
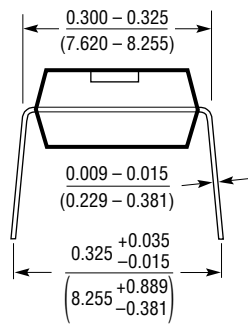
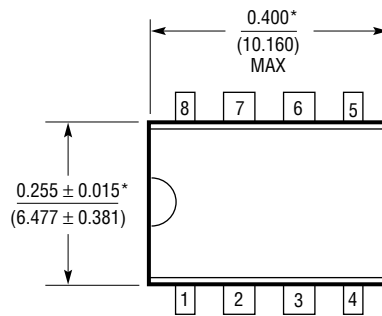

\*THESE DIMENSIONS DO NOT INCLUDE MOLD FLASH OR PROTRUSIONS.  
 MOLD FLASH OR PROTRUSIONS SHALL NOT EXCEED 0.010 INCH (0.254mm)

N8 1098

# PACKAGE DESCRIPTION

## S8 Package 8-Lead Plastic Small Outline (Narrow .150 Inch) (Reference LTC DWG # 05-08-1610)

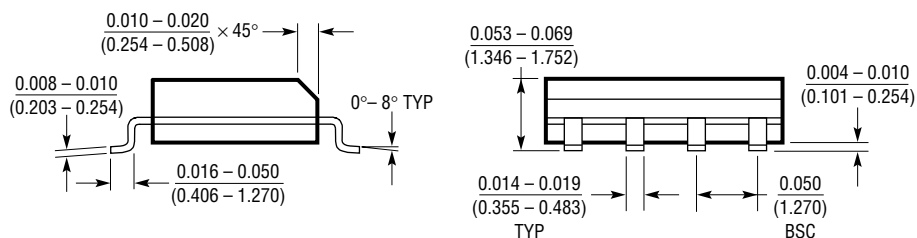
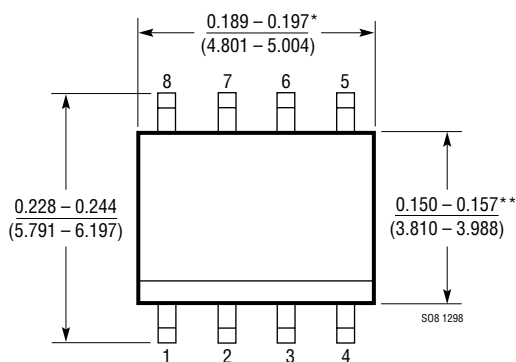

\*DIMENSION DOES NOT INCLUDE MOLD FLASH. MOLD FLASH SHALL NOT EXCEED 0.006" (0.152mm) PER SIDE

\*\*DIMENSION DOES NOT INCLUDE INTERLEAD FLASH. INTERLEAD FLASH SHALL NOT EXCEED 0.010" (0.254mm) PER SIDE

## TYPICAL APPLICATIONS

20MHz,  $A_V = 50$  Instrumentation Amplifier

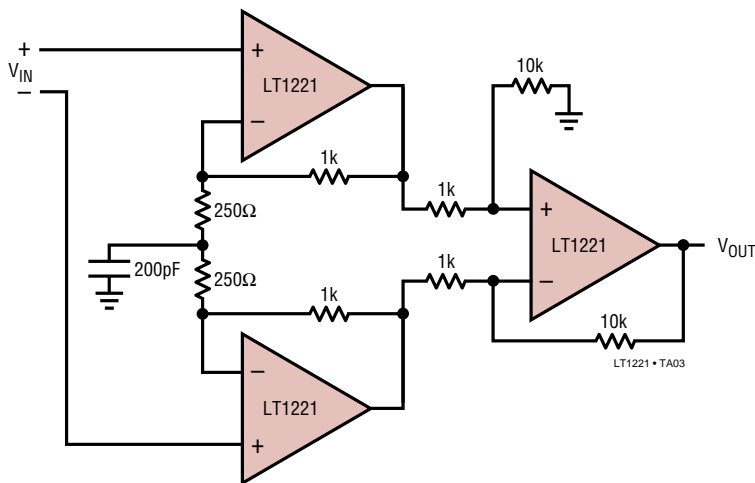

Lag Compensation

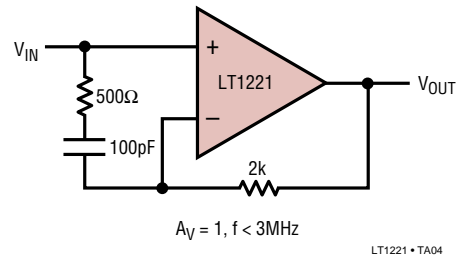

Cable Driver

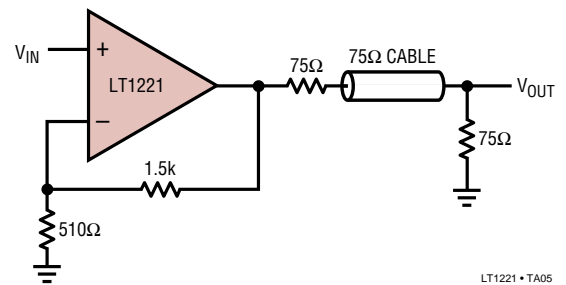

## RELATED PARTS

PART NUMBER	DESCRIPTION	COMMENTS
LT1220	45MHz, 250V/μs Amplifier	Unity Gain Stable Version of the LT1221
LT1222	500MHz, 200V/μs Amplifier	$A_V \geq 10$ Version of the LT1221